



MESA DE TRABALHO
COM BANDEJA

 **ractem**
RACKING SYSTEM

MESA DE TRABALHO COM BANDEJA

- ✓ Suporta até **640 kg por prateleira**
- ✓ **Níveis reguláveis cada 38 mm** em altura
- ✓ **Pintura em pó epóxi** de grande resistência
- ✓ Ideal para **trabalhar de pé**
- ✓ Montagem **sem parafusos**
- ✓ **Disponível com 3 níveis**

DIMENSÕES (mm)

ALTURA: 914

COMPRIMENTO: 1200 | 1500 | 1800 | 2000

LARGURA: 450 | 600 | 800 | 1000



CORES

RAL
5019

RAL
7035

RAL
2004

COMBINAÇÕES

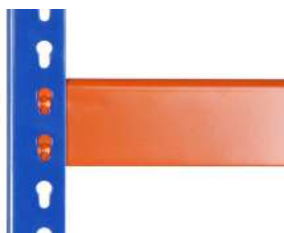

AZUL | LARANJA

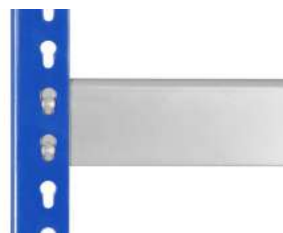

AZUL | CINZENTO

MATERIAIS DA PRATELEIRA



AGLOMERADO
16 mm de espessura



MELAMINA SEM ORLA
16 mm de espessura



MELAMINA COM ORLA
16 mm de espessura

ESCORAS

- Fabricadas em aço e pintadas com pintura em pó epóxi em cor azul.
- Escoras concebidas para poderem ajustar os níveis a cada 38 mm de altura.
- Inclui protetores de plástico para os pés.

DIMENSÕES (mm)
ALTURA: 914

COR

RAL
5019

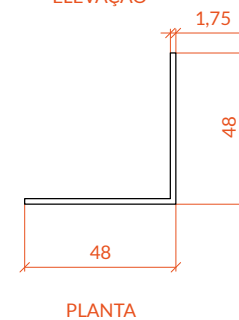
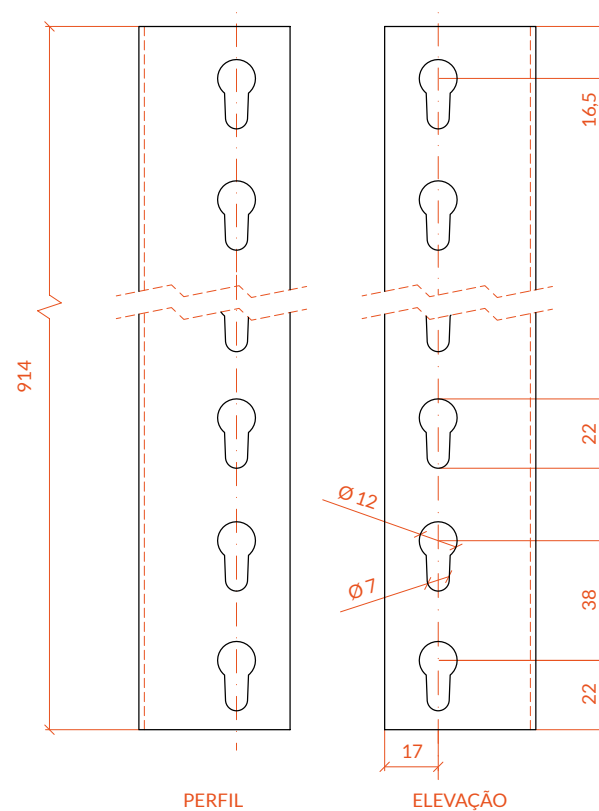
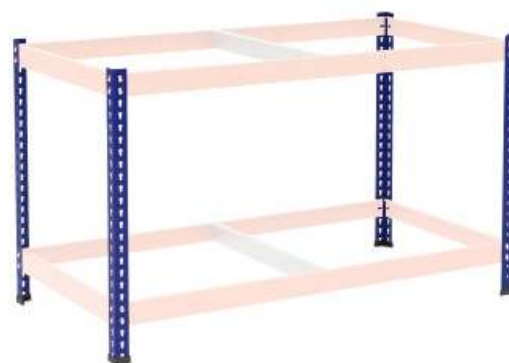

Protetores de plástico

MESA DE TRABALHO COM BANDEJA / ELEMENTOS ESTRUTURAIS

SUPERFÍCIES DE TRABALHO

CADA SUPERFÍCIE DE TRABALHO É COMPOSTA POR:

- 2 montantes para o comprimento.
- 2 montantes para a largura.
- 1 painel em aglomerado ou melamina branca (com ou sem orla) de 16 mm de espessura.
- Travessas de reforço (ver página 7).

* A mesa de trabalho pode ser configurada com um máximo de 3 níveis.

DIMENSÕES (mm)

COMPRIMENTO: 1200 | 1500 | 1800 | 2000

LARGURA: 450 | 600 | 800 | 1000

CAPACIDADE DE CARGA (kg)

⚠ Carga uniformemente distribuída por cada nível.

COMPRIMENTO (mm)	LARGURA			
	450	600	800	1000
1200	640kg	640 kg	640 kg	640 kg
1500	640 kg	640 kg	640 kg	640 kg
1800	420 kg	420 kg	420 kg	420 kg
2000	400 kg	400 kg	620 kg	620 kg



*Mesa de trabalho com 3 níveis

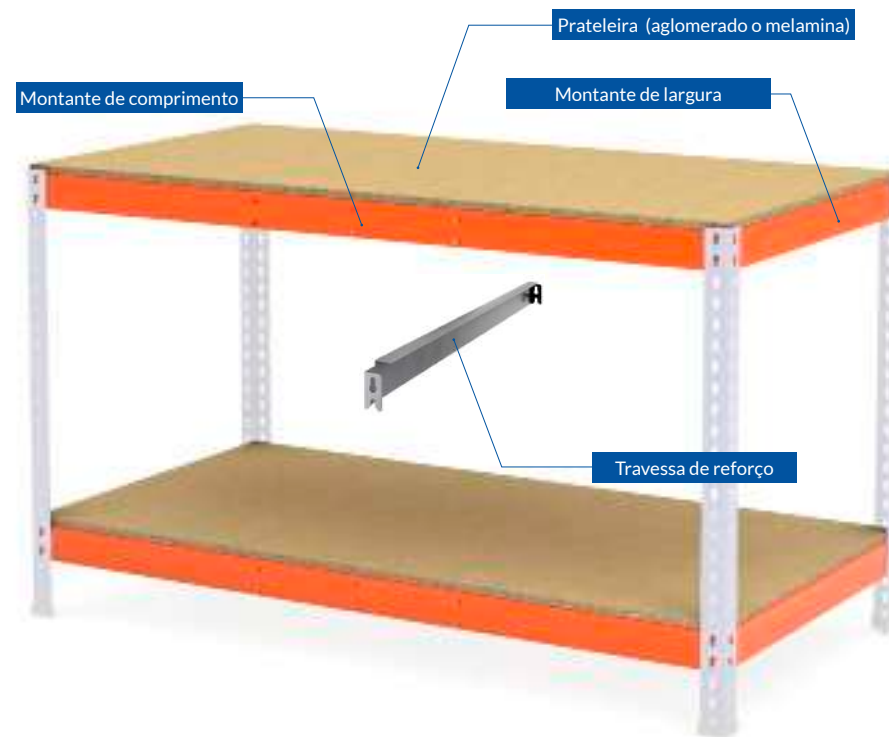

MESA DE TRABALHO COM BANDEJA / ELEMENTOS ESTRUTURAIS

SUPERFÍCIE DE TRABALHO

MONTANTES DE COMPRIMENTO

- Fabricados em aço e pintados com pintura em pó epóxi de grande resistência.
- Montantes em forma de “U” e “L” de acordo com o tamanho.
- Montagem rápida e fácil por meio de sistema de encaixe.

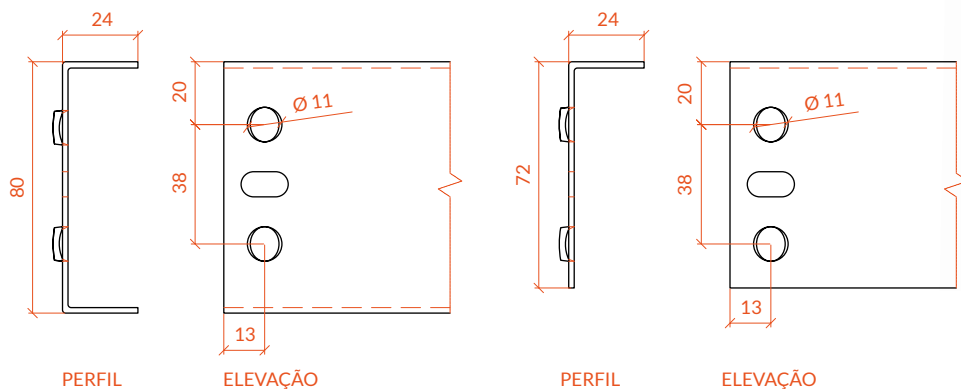

PERFIL

ELEVAÇÃO

PERFIL

ELEVAÇÃO

MONTANTES EM FORMA DE “U”

MONTANTES EM FORMA DE “L”

DIMENSÕES (mm)

COMPRIMENTO: 1200 | 1500 | 1800 | 2000

CORES

RAL
2004

RAL
7035



MONTANTES DE COMPRIMENTO PARA 2 NÍVEIS DE CARGA

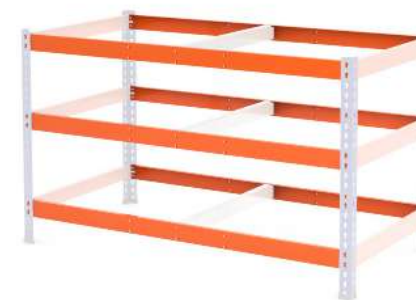

MONTANTES DE COMPRIMENTO PARA 3 NÍVEIS DE CARGA

MESA DE TRABALHO COM BANDEJA / ELEMENTOS ESTRUTURAIS

SUPERFÍCIE DE TRABALHO

MONTANTES DE LARGURA

- Fabricados em aço e disponíveis em cor de laranja ou cinzento.
- Pintura em pó epóxi de grande resistência.
- Montagem rápida e fácil por meio de sistema de encaixe.



DIMENSÕES (mm)

COMPRIMENTO:

450 | 600 | 800 | 1000

CORES

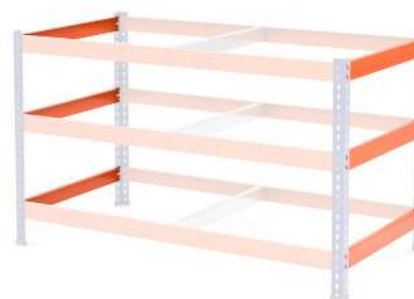
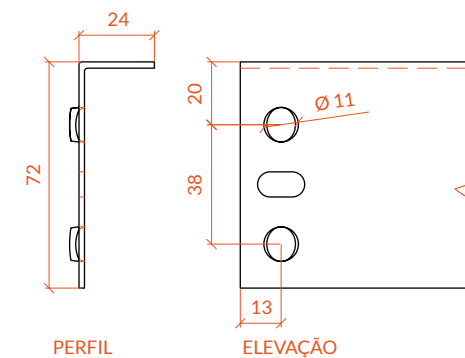
RAL
2004RAL
7035MONTANTES DE LARGURA
PARA 2 NÍVEISMONTANTES DE LARGURA
PARA 3 NÍVEIS

PERFIL

ELEVAÇÃO

MESA DE TRABALHO COM BANDEJA / ELEMENTOS ESTRUTURAIS

NÍVEIS DE CARGA

TRAVESSAS DE REFORÇO

- Fabricadas em aço galvanizado.
- Montagem rápida e fácil por meio de sistema de encaixe.

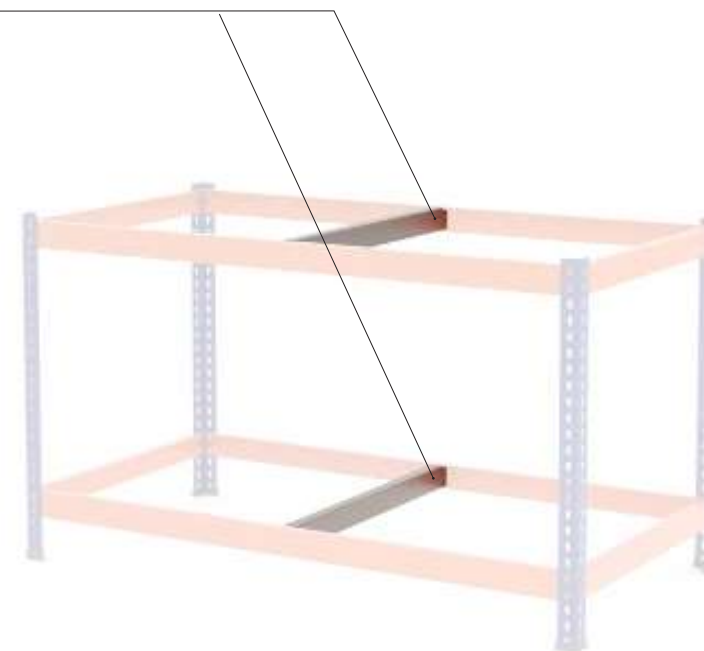
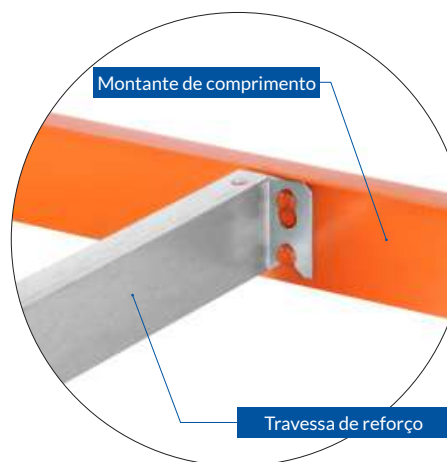

DIMENSÕES (mm)

COMPRIMENTO: 450 | 600 | 800 | 1000

NÚMERO DE TRAVESSAS POR NÍVEL

COMPRIMENTO (mm)	LARGURA			
	450	600	800	1000
1200	1	1	1	1
1500	1	1	1	1
1800	1	1	1	2
2000	1	1	2	2

COR

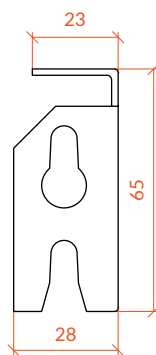

PERFIL

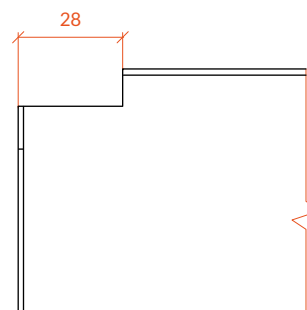

ELEVAÇÃO

NÍVEIS DE CARGA

PRATELEIRAS: AGLOMERADO / MELAMINA BRANCA

AGLOMERADO
16 mm de espessura

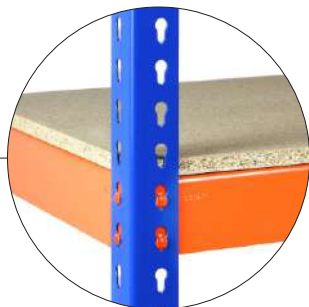

MELAMINA SEM ORLA
16 mm de espessura

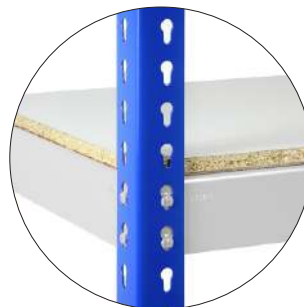

MELAMINA COM ORLA
16 mm espesurra





 **ractem**
RACKING SYSTEM

Tel: +351 21 556 5408
E-mail: contato@ractem.pt
www.ractem.pt

ESPAÑA | FRANCE | DEUTSCHLAND | ITALIA | PORTUGAL | ÖSTERREICH | BELGIQUE | NEDERLAND